

PENKO Engineering B.V.

Your Partner for Fully Engineered Factory Solutions



How to...
Connect a FLEX to a FLEX 2100, FLEX or
FLEX 2ch. – 4ch.



an ETC Company

Table of Contents

Ethernet.....	3
Set up the FLEX (Master).....	3
Set up the FLEX (Slave).....	4
Checking the connection.....	5
CAN bus.....	8
Set up the FLEX (Master).....	9
Set up the FLEX (Slave).....	9
Checking the connection.....	10
RS232.....	13
Set up the FLEX (Master).....	14
Set up the FLEX (Slave).....	14
Checking the connection.....	15
RS422.....	17
Set up the FLEX (Master).....	18
Set up the FLEX (Slave).....	18
Checking the connection.....	19

Ethernet

Using Ethernet or CAN bus Buslink will show the weight value, inputs, outputs and markers.

Use an Ethernet crossover cable to connect the FLEX to a FLEX, FLEX2100 or FLEX 2ch. – 4ch directly, or use a switch to connect one or more FLEX's.

Set up the FLEX (Master)

Go to **Menu → System Setup → Port Setup → Ethernet Setup** Set the **IP Address**.

Note: the first 3 numbers must be the same as the FLEX (Slave).

The screenshot shows the 'Ethernet Setup' menu. At the top, it displays 'TAC:00000065' and 'CHL:00000100'. The main fields are: IP Number (192.168.151.061), Subnet Mask (255.255.255.000), Gateway (000.000.000.000), Speed (Auto), and Name (empty). Each field has an 'EDIT' button. At the bottom, there are 'Cancel', 'Next', and 'OK' buttons. The PENKO logo and 'INDICATOR / CONTROLLER' status are visible at the bottom.

Press **Next**. Set **Buslink Address** on “1” and **Buslink Subaddr** on “0”. Press **OK** to save settings.

The screenshot shows the 'Ethernet Setup' menu with 'DHCP' disabled. The main fields are: Port (6768), Buslink Address (1), and Buslink Subaddr (0). Each field has an 'EDIT' button. At the bottom, there are 'Cancel', 'Prev', and 'OK' buttons. The PENKO logo and 'INDICATOR / CONTROLLER' status are visible at the bottom.

Set up the FLEX (Slave)

Go to **Menu** → **System Setup** → **Port Setup** → **Ethernet Setup** Set the **IP Address**.

Note: the first 3 numbers must be the same as the FLEX (Master).

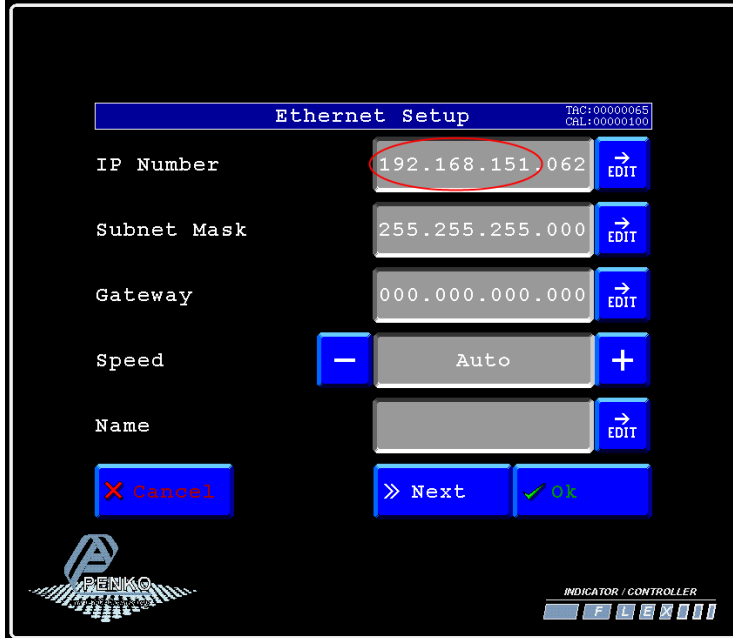

Press **Next**. Set **Buslink Address** on "1" and **Buslink Subaddr** on "2". Press **OK** to save settings.

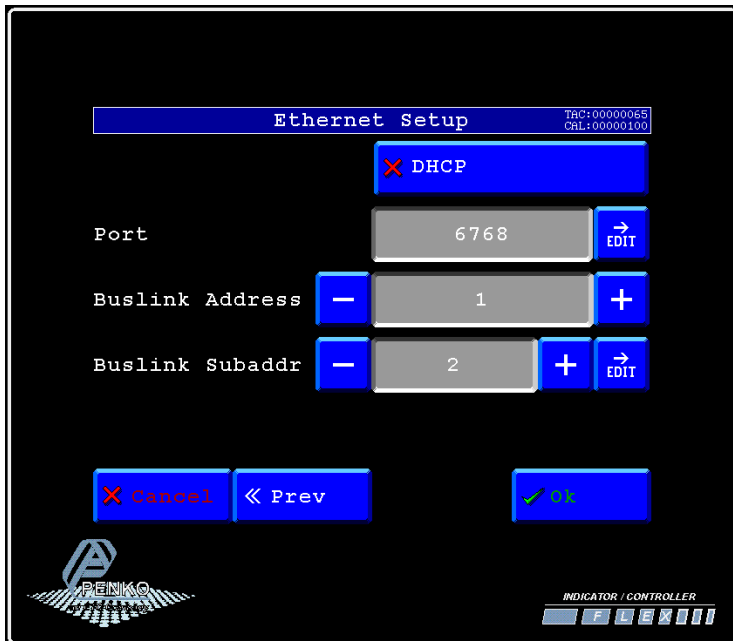

Checking the connection

To check if the connection works, use the FLEX (Master) and go to **Menu → Status → Indicators → Device**. Now you should see the values of the FLEX (Slave) from 116 to 130. The values are described below.

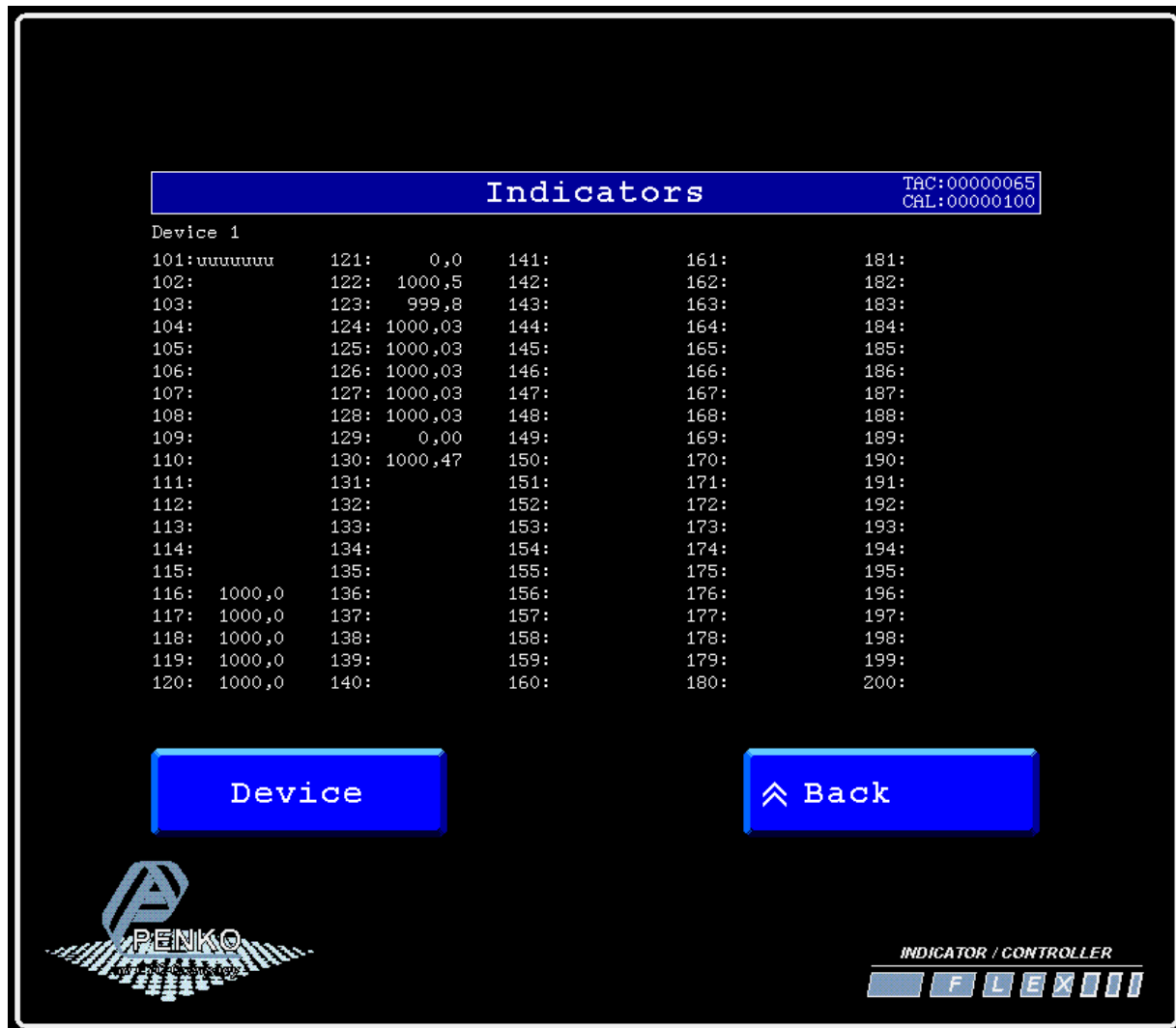

Indicator number	Function	Description
1	Weigher	The actual weight of the Indicator.
2	Fast Gross	The weight without filtering and Tare.
3	Fast Net	The weight without filtering and Tare deducted.
4	Display Gross	The weight with Display filtering and without Tare.
5	Display Net	The weight with Display filtering and Tare deducted.
6	Tare	The weight of an empty container. Gross – Tare = Net.
7	Peak	The highest point weighted on the Indicator.
8	Valley	The lowest point weighted on the Indicator.

PENKO How to...

Connect a FLEX to a FLEX 2100, FLEX or FLEX 2ch. – 4ch.

Indicator number	Function	Description
9	Weigher x10	The actual weight of the Indicator with 1 extra decimal point for more accuracy.
10	Fast Gross x10	The weight without filtering and Tare with 1 extra decimal point for more accuracy.
11	Fast Net x10	The weight without filtering and Tare deducted with 1 extra decimal point for more accuracy.
12	Display Gross x10	The weight with Display filtering and without Tare with 1 extra decimal point for more accuracy.
13	Display Net x10	The weight with Display filtering and Tare deducted with 1 extra decimal point for more accuracy.
14	Tare x10	The weight of an empty container. Gross – Tare = Net with 1 extra decimal point for more accuracy.
15	Peak x10	The highest point weighted on the Indicator with 1 extra decimal point for more accuracy.

Go back to **Status** and select **I/O + Markers** to see the status of the Inputs, Outputs and Markers. If an Input, Output or Marker is high it will show as a “H”. In the example below input 4 is high.

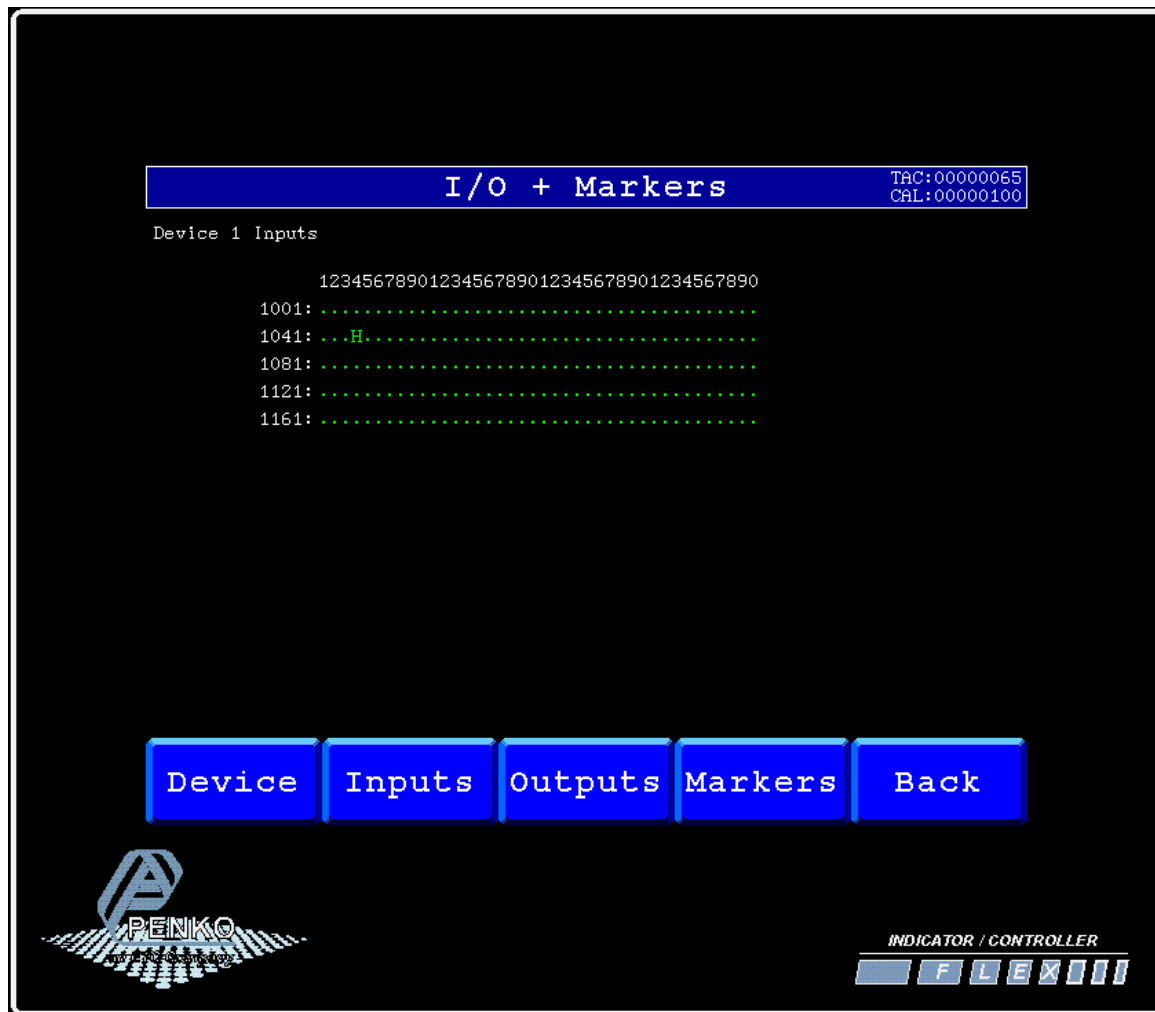

If you want to connect more than one FLEX's, use the following settings for the controllers:

Device number	Address	Sub address	weight values shown on the FLEX	Inputs shown on the FLEX	Outputs shown on the FLEX	Markers shown on the FLEX
1	1	2	116-130	1041-1080	1241-1276	1441-1480
2	1	3	131-145	1081-1120	1281-1316	1481-1520
3	1	4	146-160	1121-1160	1321-1356	1521-1560
4	1	5	161-175	1161-1200	1361-1396	1561-1600
5	2	1	201-215	2001-2040	2201-2236	2401-2440
6	2	2	216-230	2041-2080	2241-2276	2441-2480
7	2	3	231-245	2081-2120	2281-2316	2481-2520
8	2	4	246-260	2121-2160	2321-2356	2521-2560
9	2	5	261-275	2161-2200	2361-2396	2561-2600
10	3	1	301-315	3001-3040	3201-3236	3401-3440
11	3	2	316-330	3041-3080	3241-3276	3441-3480
12	3	3	331-345	3081-3120	3281-3316	3481-3520
13	3	4	346-360	3121-3160	3321-3356	3521-3560
14	3	5	361-375	3161-3200	3361-3396	3561-3600
15	4	1	401-415	4001-4040	4201-4236	4401-4440
16	4	2	416-430	4041-4080	4241-4276	4441-4480
17	4	3	431-445	4081-4120	4281-4316	4481-4520
18	4	4	446-460	4121-4160	4321-4356	4521-4560
19	4	5	461-475	4161-4200	4361-4396	4561-4600
20	5	1	501-515	5001-5040	5201-5236	5401-5440
21	5	2	516-530	5041-5080	5241-5276	5441-5480
22	5	3	531-545	5081-5120	5281-5316	5481-5520
23	5	4	546-560	5121-5160	5321-5356	5521-5560
24	5	5	561-575	5161-5200	5361-5396	5561-5600
25	6	1	601-615	6001-6040	6201-6236	6401-6440
26	6	2	616-630	6041-6080	6241-6276	6441-6480
27	6	3	631-645	6081-6120	6281-6316	6481-6520
28	6	4	646-660	6121-6160	6321-6356	6521-6560
29	6	5	661-675	6161-6200	6361-6396	6561-6600
30	7	1	701-715	7001-7040	7201-7236	7401-7440
31	7	2	716-730	7041-7080	7241-7276	7441-7480
32	7	3	731-745	7081-7120	7281-7316	7481-7520
33	7	4	746-760	7121-7160	7321-7356	7521-7560
34	7	5	761-775	7161-7200	7361-7396	7561-7600
35	8	1	801-815	8001-8040	8201-8236	8401-8440
36	8	2	816-830	8041-8080	8241-8276	8441-8480
37	8	3	831-845	8081-8120	8281-8316	8481-8520
38	8	4	846-860	8121-8160	8321-8356	8521-8560
39	8	5	861-875	8161-8200	8361-8396	8561-8600

CAN bus

Using Ethernet or CAN bus Buslink will show the weight value, inputs, outputs and markers.

First of all you will need to connect one or more FLEX's to the FLEX, this can be done by connection a cable with three wires and a shield parallel (**Can-H1** goes to **Can-H1**, **GND** goes to **GND**, **Can-L1** goes to **Can-L1** and **Shield** goes to **Shield**). The first and last FLEX on the cable must use the bus termination. Place a resistor of 120 Ω between **Can-H1** and **Can-L1** on the first and last FLEX.

Connect the FLEX 2100 to a FLEX or FLEX 2ch. – 4ch.

FLEX 2100		FLEX NO:1	FLEX No:2	FLEX 2100 No:3
CanH	Connect to	Can-H1	Can-H1	CanH
GND	Connect to	GND	GND	GND
CanL	Connect to	Can-L1	Can-L1	CanL
Shield	Connect to	Shield	Shield	Shield

Connect the FLEX to a FLEX 2100

FLEX or FLEX 2ch. – 4ch.		FLEX NO:1	FLEX 2100 No:2	FLEX 210000 No:3
Can-H1	Connect to	Can-H1	CanH	CanH
GND	Connect to	GND	GND	GND
Can-L1	Connect to	Can-L1	CanL	CanL
Shield	Connect to	Shield	Shield	Shield

Set up the FLEX (Master)

Go to **Menu** → **System Setup** → **Port Setup** → **CAN1 Port**. Set **Protocol** to “Buslink”, **Baudrate** to “250K”, **Buslink Address** to “1” and **Buslink Subaddr** to “1”. Press on “OK” to save settings.



Set up the FLEX (Slave)

Go to **Menu** → **System Setup** → **Port Setup** → **CAN1 Port**. Set **Protocol** to “Buslink”, **Baudrate** to “250K”, **Buslink Address** to “1” and **Buslink Subaddr** to “2”. Press on “OK” to save settings.

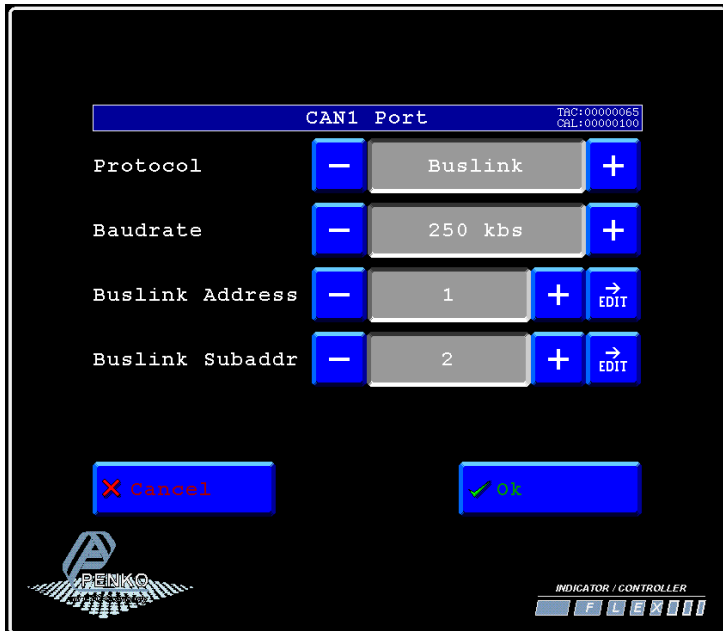

Checking the connection

To check if the connection works, use the FLEX (Master) and go to **Menu → Status → Indicators → Device**. Now you should see the values of the FLEX (Slave) from 116 to 130. The values are described below.

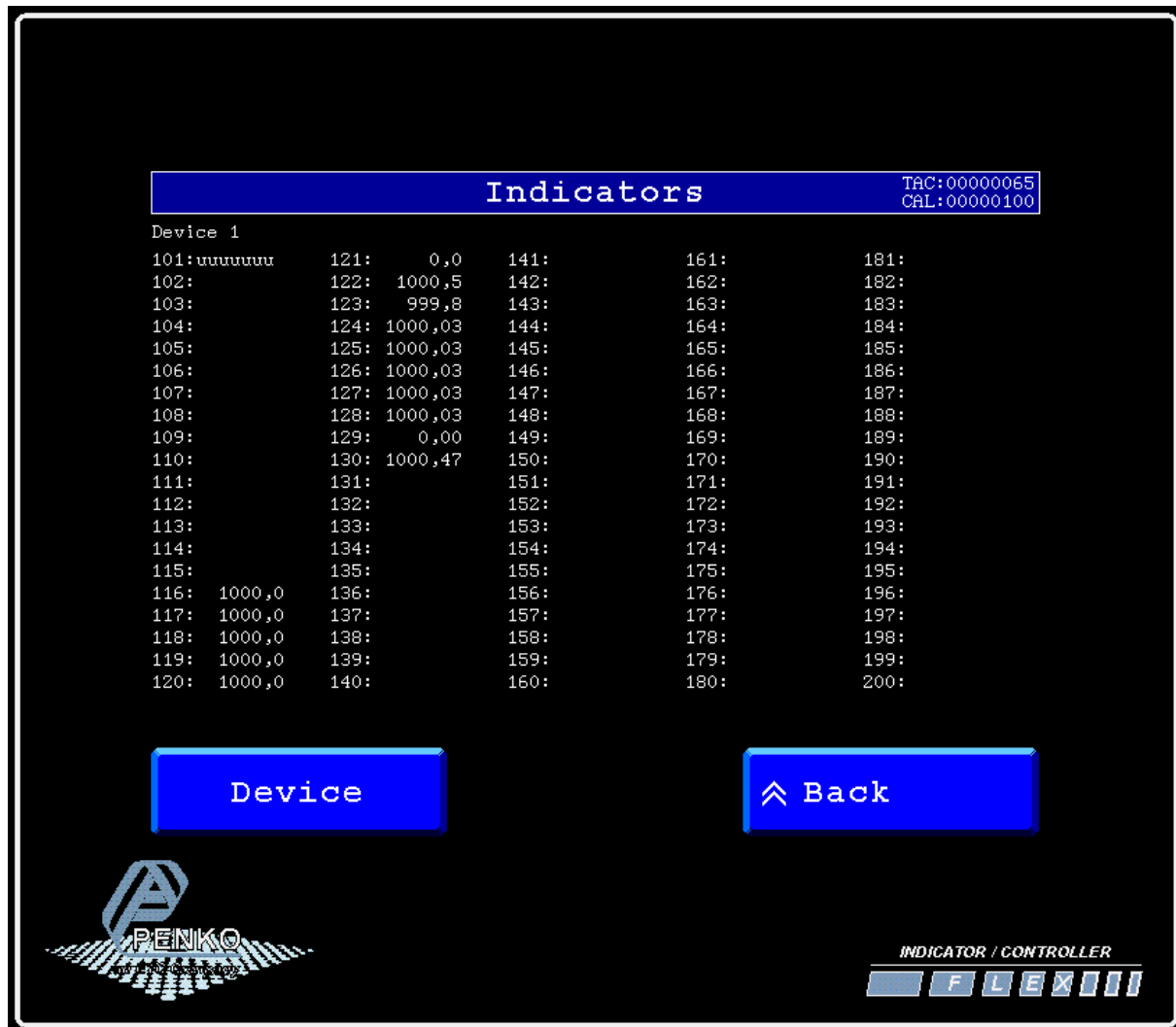

Indicator number	Function	Description
1	Weigher	The actual weight of the Indicator.
2	Fast Gross	The weight without filtering and Tare.
3	Fast Net	The weight without filtering and Tare deducted.
4	Display Gross	The weight with Display filtering and without Tare.
5	Display Net	The weight with Display filtering and Tare deducted.
6	Tare	The weight of an empty container. Gross – Tare = Net.
7	Peak	The highest point weighted on the Indicator.
8	Valley	The lowest point weighted on the Indicator.

PENKO How to...

Connect a FLEX to a FLEX 2100, FLEX or FLEX 2ch. – 4ch.

Indicator number	Function	Description
9	Weigher x10	The actual weight of the Indicator with 1 extra decimal point for more accuracy.
10	Fast Gross x10	The weight without filtering and Tare with 1 extra decimal point for more accuracy.
11	Fast Net x10	The weight without filtering and Tare deducted with 1 extra decimal point for more accuracy.
12	Display Gross x10	The weight with Display filtering and without Tare with 1 extra decimal point for more accuracy.
13	Display Net x10	The weight with Display filtering and Tare deducted with 1 extra decimal point for more accuracy.
14	Tare x10	The weight of an empty container. Gross – Tare = Net with 1 extra decimal point for more accuracy.
15	Peak x10	The highest point weighted on the Indicator with 1 extra decimal point for more accuracy.

Go back to **Status** and select **I/O + Markers** to see the status of the Inputs, Outputs and Markers. . If an Input, Output or Marker is high it will show as a “H”. In the example below input 4 is high.

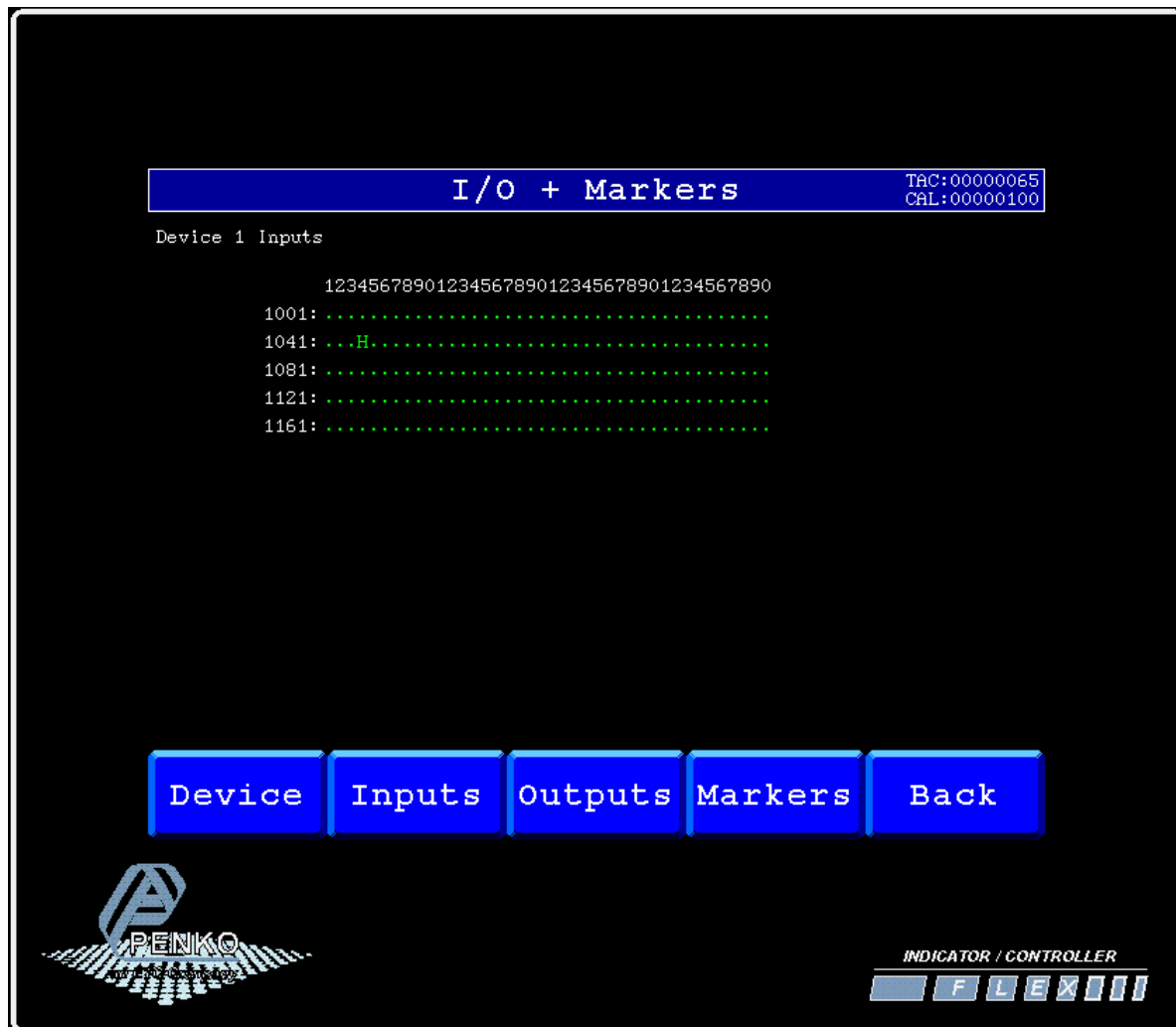

If you want to connect more than one FLEX's, use the following settings for the controllers.

Device number	Address	Sub address	weight values shown on the FLEX	Inputs shown on the FLEX	Outputs shown on the FLEX	Markers shown on the FLEX
1	1	2	116-130	1041-1080	1241-1276	1441-1480
2	1	3	131-145	1081-1120	1281-1316	1481-1520
3	1	4	146-160	1121-1160	1321-1356	1521-1560
4	1	5	161-175	1161-1200	1361-1396	1561-1600
5	2	1	201-215	2001-2040	2201-2236	2401-2440
6	2	2	216-230	2041-2080	2241-2276	2441-2480
7	2	3	231-245	2081-2120	2281-2316	2481-2520
8	2	4	246-260	2121-2160	2321-2356	2521-2560
9	2	5	261-275	2161-2200	2361-2396	2561-2600
10	3	1	301-315	3001-3040	3201-3236	3401-3440
11	3	2	316-330	3041-3080	3241-3276	3441-3480
12	3	3	331-345	3081-3120	3281-3316	3481-3520
13	3	4	346-360	3121-3160	3321-3356	3521-3560
14	3	5	361-375	3161-3200	3361-3396	3561-3600
15	4	1	401-415	4001-4040	4201-4236	4401-4440
16	4	2	416-430	4041-4080	4241-4276	4441-4480
17	4	3	431-445	4081-4120	4281-4316	4481-4520
18	4	4	446-460	4121-4160	4321-4356	4521-4560
19	4	5	461-475	4161-4200	4361-4396	4561-4600
20	5	1	501-515	5001-5040	5201-5236	5401-5440
21	5	2	516-530	5041-5080	5241-5276	5441-5480
22	5	3	531-545	5081-5120	5281-5316	5481-5520
23	5	4	546-560	5121-5160	5321-5356	5521-5560
24	5	5	561-575	5161-5200	5361-5396	5561-5600
25	6	1	601-615	6001-6040	6201-6236	6401-6440
26	6	2	616-630	6041-6080	6241-6276	6441-6480
27	6	3	631-645	6081-6120	6281-6316	6481-6520
28	6	4	646-660	6121-6160	6321-6356	6521-6560
29	6	5	661-675	6161-6200	6361-6396	6561-6600
30	7	1	701-715	7001-7040	7201-7236	7401-7440
31	7	2	716-730	7041-7080	7241-7276	7441-7480
32	7	3	731-745	7081-7120	7281-7316	7481-7520
33	7	4	746-760	7121-7160	7321-7356	7521-7560
34	7	5	761-775	7161-7200	7361-7396	7561-7600
35	8	1	801-815	8001-8040	8201-8236	8401-8440
36	8	2	816-830	8041-8080	8241-8276	8441-8480
37	8	3	831-845	8081-8120	8281-8316	8481-8520
38	8	4	846-860	8121-8160	8321-8356	8521-8560
39	8	5	861-875	8161-8200	8361-8396	8561-8600

RS232

Using RS232 and RS422 will only show the weight value.

With RS232 it is only possible to connect one FLEX to a FLEX, but if you use RS422 it is possible to connect up to 15 FLEX's.

Use a crossover Female to Female Serial cable to connect a FLEX to a FLEX or a FLEX 2ch. – 4ch. If you want to connect a FLEX to a FLEX2100, use the following wiring diagram.

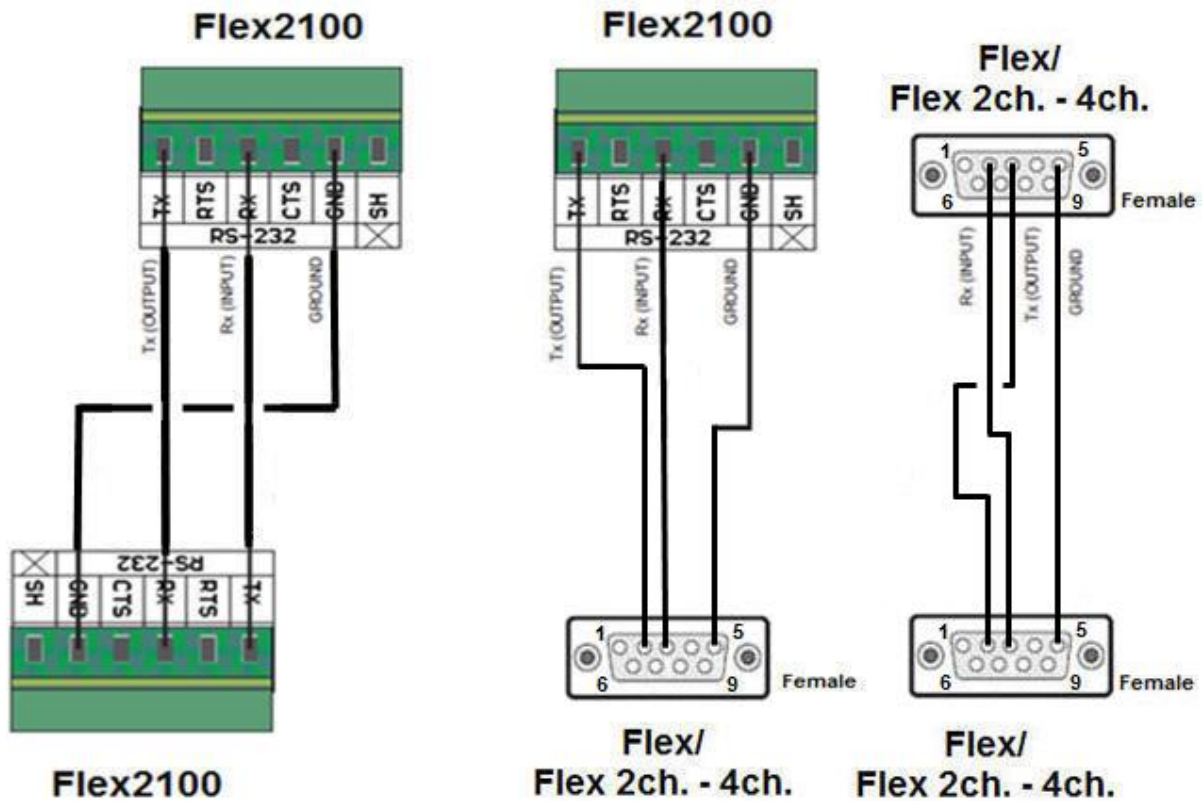

Set up the FLEX (Master)

Go to **Menu** → **System Setup** → **Port Setup** → **RS232 Port**. Set **Protocol** to “Indicator”, **Address** to “1”, **Baudrate** to “57600”, **Parity** to “None” and **Stopbits** to “1”. Press “Ok” to save settings.

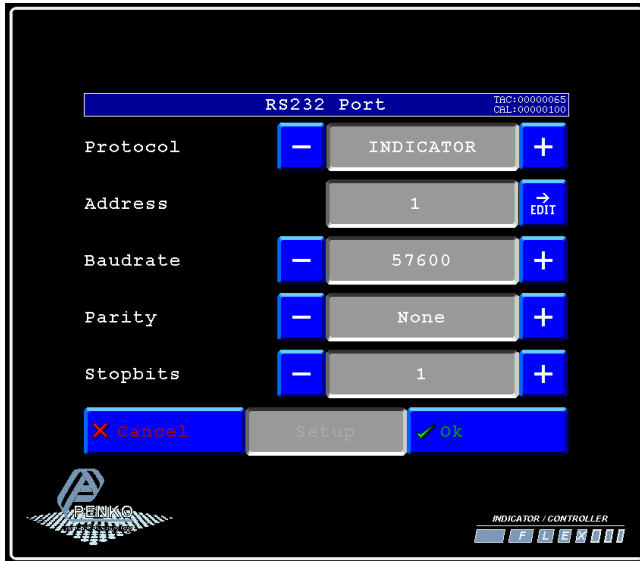

Set up the FLEX (Slave)

Go to **Menu** → **System Setup** → **Port Setup** → **RS232 Port**. Set **Protocol** to “NPV Slave”, **Address** to “1”, **Baudrate** to “57600”, **Parity** to “None” and **Stopbits** to “1”. Press “Ok” to save settings.



Checking the connection

To check if the connection works, use the FLEX and go to **Menu → Status → Indicators → Device**. Now you should see the value of the FLEX between **002 and 016** (depending on the address you have given the FLEX). **Address + 1**.



Device number	Address	Value shown on the FLEX
1	1	002
2	2	003
3	3	004
4	4	005
5	5	006
6	6	007
7	7	008
8	8	009



PENKO How to...

Connect a FLEX to a FLEX 2100, FLEX or FLEX 2ch. – 4ch.

Device number	Address	Value shown on the FLEX
9	9	010
10	10	011
11	11	012
12	12	013
13	13	014
14	14	015
15	15	016

RS422

Using RS232 and RS422 will only show the weight value.

With RS232 it is only possible to connect one FLEX to a FLEX, but if you use RS422 it is possible to connect up to 15 FLEX's.

Use the wiring diagrams below to connect the FLEX to your FLEX 2100, FLEX, or FLEX 2ch. – 4ch. You can connect up to 15 FLEX's.

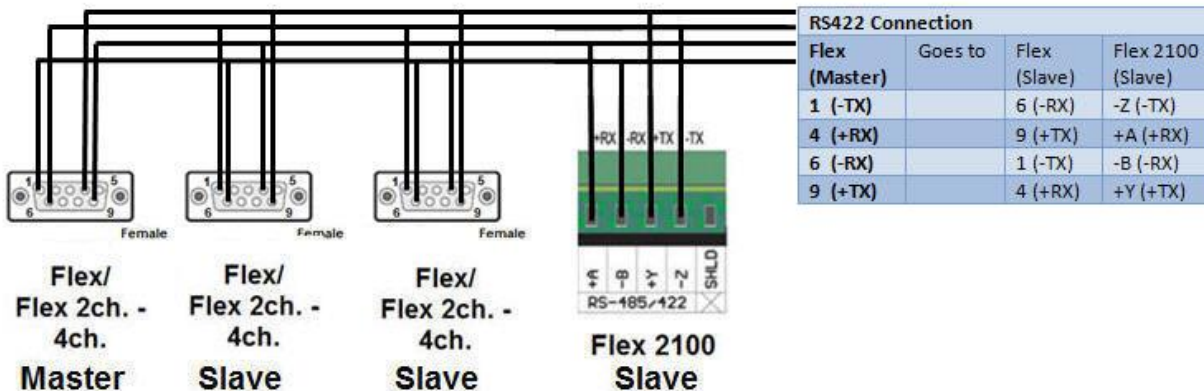
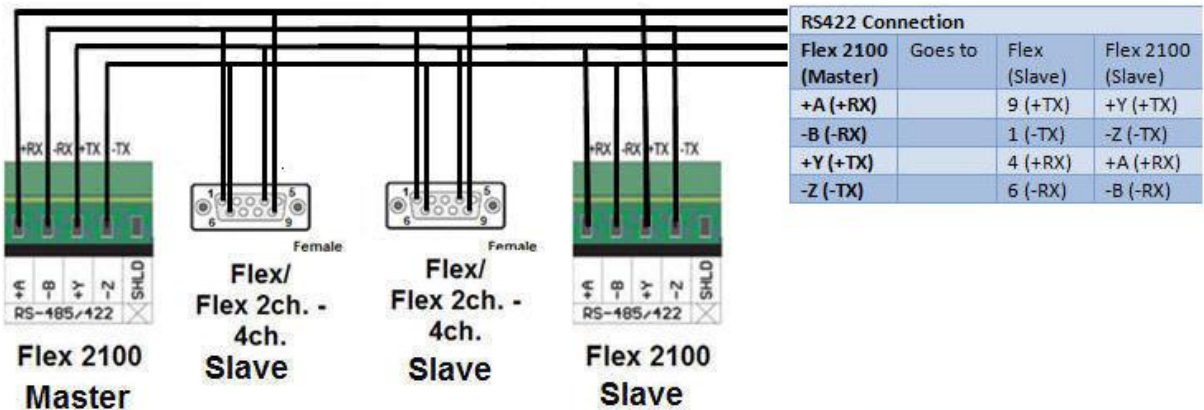

PENKO How to...

Connect a FLEX to a FLEX 2100, FLEX or FLEX 2ch. – 4ch.

Set up the FLEX (Master)

Go to **Menu** → **System Setup** → **Port Setup** → **RS422 Port**. Set **Protocol** to “Indicator”, **Address** to “1”, **Baudrate** to “57600”, **Parity** to “None” and **Stopbits** to “1”. Press “Ok” to save settings.

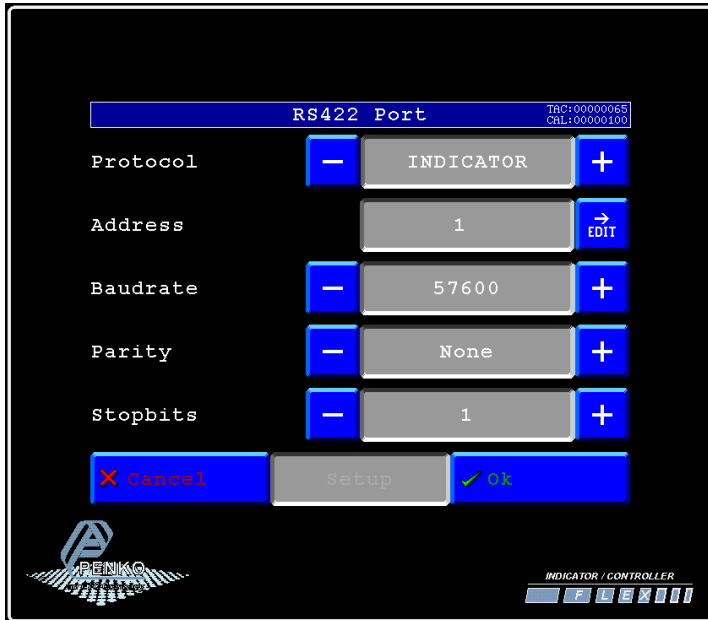

Set up the FLEX (Slave)

Go to **Menu** → **System Setup** → **Port Setup** → **RS422 Port**. Set **Protocol** to “NPV Slave”, **Address** between “1 and 15”, **Baudrate** to “57600”. Press “Ok” to save settings.



Checking the connection

To check if the connection works, use the FLEX and go to **Menu → Status → Indicators → Device**. Now you should see the value of the FLEX between **002 and 016** (depending on the address you have given the SGM). **Address + 1**.

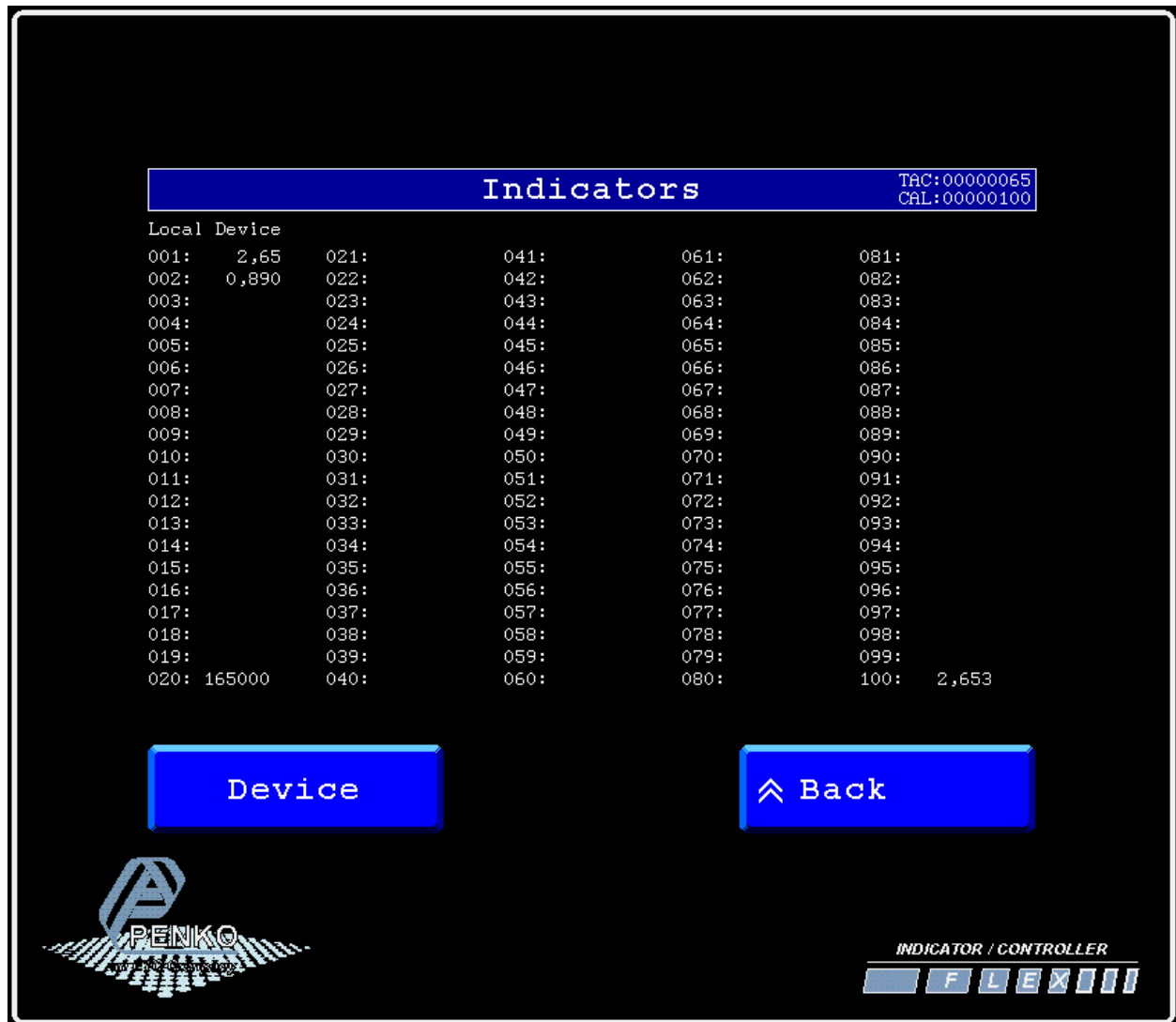

Device number	Address	Value shown on the FLEX
1	1	002
2	2	003
3	3	004
4	4	005
5	5	006
6	6	007
7	7	008

PENKO How to...

Connect a FLEX to a FLEX 2100, FLEX or FLEX 2ch. – 4ch.

Device number	Address	Value shown on the FLEX
8	8	009
9	9	010
10	10	011
11	11	012
12	12	013
13	13	014
14	14	015
15	15	016



About PENKO

Our design expertise include systems for manufacturing plants, bulk weighing, check weighing, force measuring and process control. For over 35 years, PENKO Engineering B.V. has been at the forefront of development and production of high-accuracy, high-speed weighing systems and our solutions continue to help cut costs, increase ROI and drive profits for some of the largest global brands, such as Cargill, Sara Lee, Heinz, Kraft Foods and Unilever to name but a few.

Whether you are looking for a simple stand-alone weighing system or a high-speed weighing and dosing controller for a complex automated production line, PENKO has a comprehensive range of standard solutions you can rely on.

Certifications

PENKO sets high standards for its products and product performance which are tested, certified and approved by independent expert and government organizations to ensure they meet – and even – exceed metrology industry guidelines. A library of testing certificates is available for reference on:

http://penko.com/nl/publications_certificates.html



PENKO Professional Services

PENKO is committed to ensuring every system is installed, tested, programmed, commissioned and operational to client specifications. Our engineers, at our weighing center in Ede, Netherlands, as well as our distributors around the world, strive to solve most weighing-system issues within the same day. On a monthly basis PENKO offers free training classes to anyone interested in exploring modern, high-speed weighing instruments and solutions. A schedule of training sessions is found on: www.penko.com/training

PENKO Alliances

PENKO's worldwide network: Australia, Belgium, Brazil, China, Denmark, Germany, Egypt, Finland, France, India, Italy, Netherlands, Norway, Poland, Portugal, Slovakia, Spain, Syria, Turkey, United Kingdom, South Africa, Slovakia Sweden, Switzerland and Singapore.

A complete overview you will find on: www.penko.com/dealers

